

# V-TUF<sup>®</sup>



## CORDLESS BACKPACK VACUUM CLEANER OPERATOR MANUAL



Please read this manual before using the RUCKVAC Cordless Vacuum Cleaner



# IMPORTANT SAFETY INSTRUCTIONS

When using your Vacuum, basic safety precautions should always be observed, including the following:

## VACUUM SAFETY



You must read this manual before using this product to reduce the risk of fire, electric shock, or injury.

Failure to do so can result in serious injury or death.

1. Use only as described in this manual. Use only the recommended attachments, battery, charger, and replacement parts.
2. **DO NOT** use the vacuum outdoors or on wet surfaces. **DO NOT** expose to rain or water.
3. **DO NOT** use or store vacuum in wet or moist conditions.
4. **DO NOT** try to recover any liquid with this vacuum. This vacuum is for **DRY RECOVERY** only
5. **DO NOT USE A DAMAGED VACUUM.** If the unit is not working as it should be or expected, or if it has been damaged, left outdoors, or exposed to water, take it to an **Authorised V-TUF Repair Center** for inspection and repair.
6. **DO NOT** allow the vacuum to be used as a toy. Pay close attention when using the vacuum near children.
7. **DO NOT** handle the switch or battery pack with wet hands.
8. **DO NOT** put any objects into openings. Do not use with any opening blocked, keep free of dust, lint, hair, and anything that may reduce air flow.
9. Keep hair, loose clothing, fingers, and all parts of body away from openings and moving parts.
10. Use with extra care when cleaning on stairs.
11. **DO NOT** vacuum flammable or combustible materials or anything that is burning or smoking, such as cigarettes, matches, or hot ashes.
12. Sparks inside the motor can ignite flammable vapors, to reduce the risk of fire or explosion, do not use near combustible liquids, gases, or dusts, such as gasoline or other fuels, lighter fluid, cleaners, oil-based paints, or natural gas.
13. To reduce the risk of inhaling toxic vapors or dust **DO NOT** vacuum or use near toxic or hazardous materials.
14. **DO NOT** use without filter in place.
15. Disconnect battery pack before servicing vacuum.

# GETTING TO KNOW YOUR RUCKVAC BATTERY POWER BACKPACK VACUUM

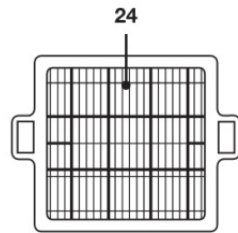
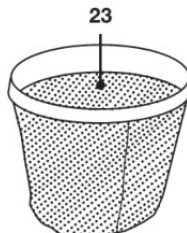
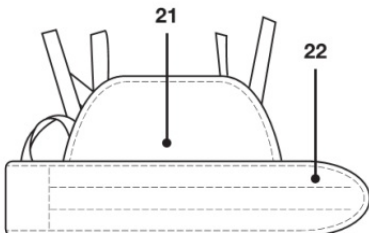
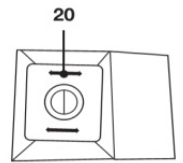
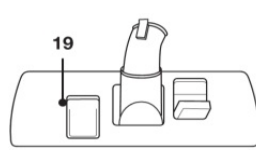
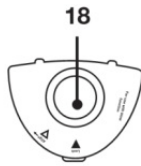
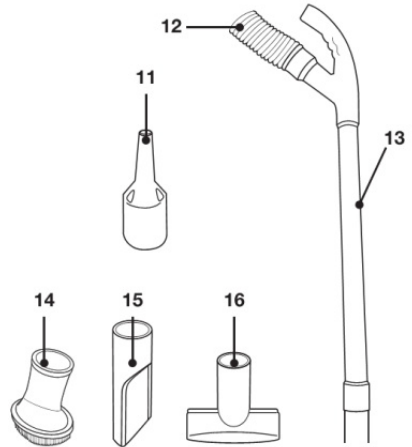
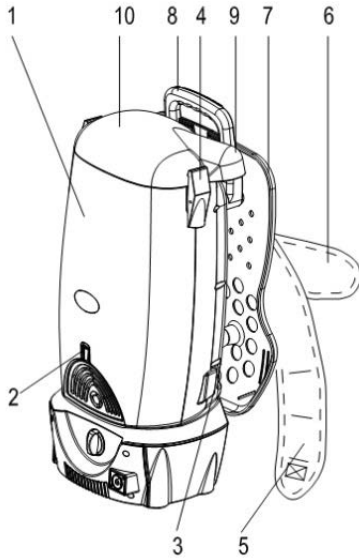

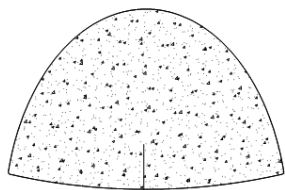

25

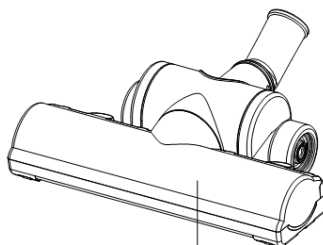

26

1. Main Unit
2. Exhaust Grill Port
3. On/Off Power Switch
4. Canister Lid Tabs
5. Waist Band
6. Shoulder Straps
7. Back Board Panel
8. Carry Handle
9. Hose Inlet
10. Canister Lid
11. Blower Attachment
12. Flexible Hose
13. Plastic Tube
14. Dusting Brush
15. Crevice Tool
16. Pet Hair Remover
17. Exhaust Grill
18. Blower Port
19. Combination floor
20. Paper Dust bag
21. Waist Band Back Support Panel
22. Waist Bang Tool Carrier
23. Cloth Dust Bag
24. HEPA Pre-Motor Filter
25. Exhaust Filter
26. Turbo Floor brush(optional)

# OPERATING INSTRUCTIONS

---

## ASSEMBLY

**IMPORTANT:** Do not use the vacuum without the **HEPA** filter and **HEPA** dust bag in place.

1. Close the power with switch and remove the flexible hose.
2. To open the canister lid press on the canister lid tabs on each side of the unit and lift canister lid. (Fig.1)
3. Pull the tab on the **HEPA** dust bag holder out slightly and flip upwards.(Fig 2)
4. Holding the **HEPA** dust bag in your hand, slice it firmly between the slots in the bag holder. (Fig 2)
5. The cardboard face of the new bag should rest securely in the dust bag cover guide.(Fig 3)
6. Ensure that the shake-out bag is in place. (Fig. 4)
7. Flip the **HEPA** bag holder over, pressing the tab on the bag holder until it clicks then replace the canister lid.
8. The canister lid can be replaced on the unit with the hose opening on the right or left, as per your preference. (Fig 5)

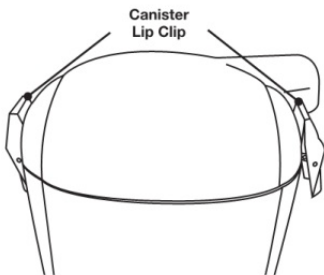

Fig 1

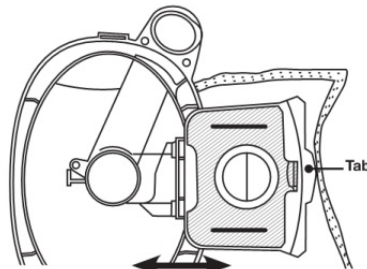

Fig 2

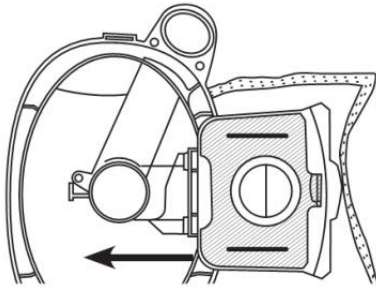

Fig 3

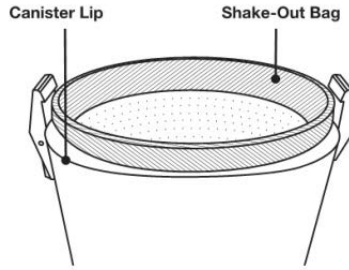
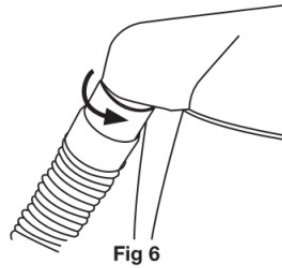
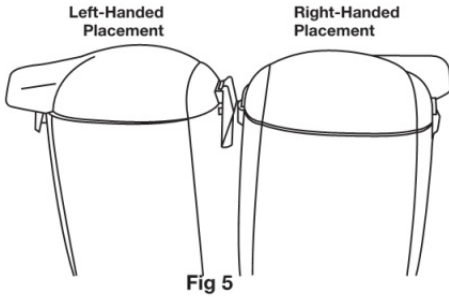

Fig 4

### **Attaching the Flexible hose to The vacuum**

The flexible hose should be connected to the Vacuum before strapping the unit on.

1. To connect the flexible hose into the hose inlet, insert the threaded end of the flexible hose into the hose inlet and turn counter-clockwise until it locks into place. (Fig 6)
2. Turn on the switch then you can operate the vacuum.



## **USING THE ATTACHMENTS**

### ● **Dusting Brush**

The dusting brush is used for the furniture

### ● **Crevice Tool**

Use for radiators, crevices, corners, baseboards and between cushions. (Fig10)

### ● **Pet Hair Remove Brush**

The pet hair remove brush is used for upholstery. The unique surface makes it an excellent tool for removing unwanted pet hair. (Fig11) **Note:** This tool is not a grooming tool and should not be used on animals.

**Caution:** Do not use Pet Hair Remove Brush on delicate or woven Fabrics that may snag. Do not use Pet Hair Remove Brush on wooden floors as this accessory might cause mild scratching.



## **Air Driven Turbo brush (Optional)**

The efficiency of your air driven turbo brush depends on the bristle brush rotating at high speed. Strong air suction is needed to accomplish this. In order to ensure that maximum air suction is maintained please read the following instructions:

1. Change the HEPA dust bag or empty the shake-out bag frequently.
2. Replace the pre-motor and exhaust filters as needed.
3. Ensure that the rotating brush is kept free of hair and string which may accumulate and decrease brush performance.
4. To attach the air driven turbo brush, insert the telescopic tube into the air driven turbo brush.
5. To adjust the suction control on the air driven turbo brush slide the suction control for more or less suction as desired the suction control.

**Note:** The driven turbo brush has a suction control on the top of the brush. Open or close to increase or decrease the suction as desired, I, e, open for high pile or closed for low pile carpets.

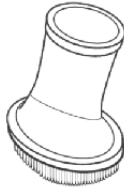

**Fig 9**



**Fig 10**

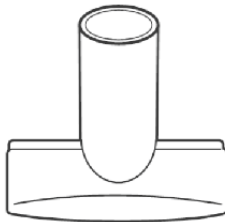

**Fig 11**

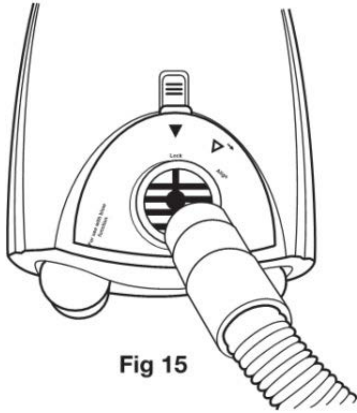

**Fig 15**

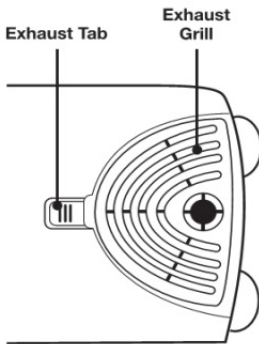

**Fig 13**

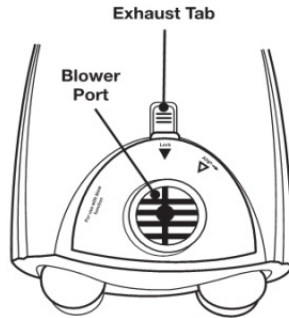

**Fig 14**

6. Replace the shake-out bag into the vacuum.
7. To replace the HEPA dust bag holder, flip the holder and press tab until it clicks.
8. Replace the canister lid onto the vacuum.

**Warning: Never** over fill the HEPA Dust bag – replace when bag is full and clean the shake-out bag and filter each time the HEPA dust bag is replaced.

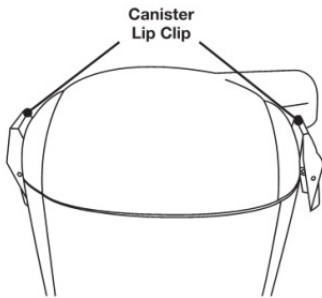

Fig 18

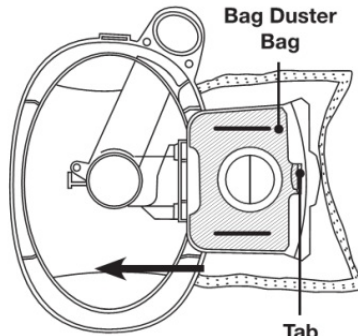

Fig 19

### **Cleaning & Replacing the Shake-Out Bag**

**Note:** Clean the shake-out bag out-doors when changing the **HEPA** dust bag. Optimum performance is achieved by using the **HEPA** dust bag with the shake-out bag decreasing the need for washing the shake-out bag.

### **Cleaning the Shake-Out Bag Used with the HEPA Dust Bag:**

1. Remove the shake-out bag, holding the handle at the bottom of the bag, shake out doors vigorously over a garbage receptacle until there is no debris or dust remaining.
2. Inspect shake-out bag regularly for tears or damage. Replace shake out bags if damage or tears are present.

### **Cleaning the Shake-Out Bag**

1. Remove the shake-out bag, empty trash can, and shake vigorously outdoors until there is no more dust.
2. The shake-out bag is hand washable in lukewarm water.
3. Allow to air dry for 24 hours. The shake-out bag should be replaced when needed.

**Never replace into the vacuum if still wet.**

4. Replace clean shake-out bag in unit and replace the canister lid.

## Using Your Vacuum

1. Ensure the battery pack is correctly assembled in the vacuum
2. Connect hose and telescopic tube if desired.
3. Correctly place shoulder straps on each shoulder and secure the waist band with hook and loop strips. (Fig.16)

**Caution:** If the waist band and both shoulder straps are not properly and securely in place the unit could fall off your back causing damage or injury.

4. Turn the unit on by pressing the switch located near the base of the unit to turn the vacuum cleaner on. (Fig.17)

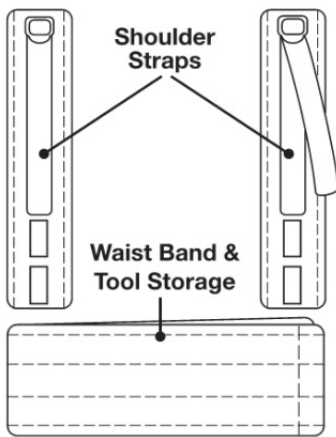

Fig 16

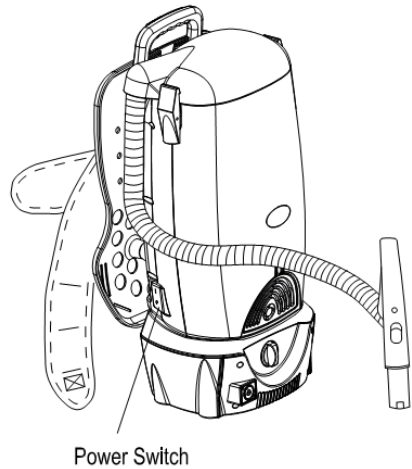

Fig 17

## Removing & Replacing HEPA Dust Bag

To remove the **HEPA** dust bag from the vacuum:

**Important: DO NOT** use the vacuum without all filters, shake-out bag, and with or without **HEPA** dust bag in place

1. To remove the **HEPA** dust bag, press on the canister lid tabs on each side of the unit and lift canister lid. (Fig.18)
2. Pull the tab on the HEPA dust bag holder out slightly and lift upwards.(Fig.18)
3. Holding the HEPA dust bag in your hand, slide it out from the slots in the bag holder and hold carefully in order to avoid dust falling out of HEPA dust bag. (Fig. 19)
4. Replace the HEPA dust bag with a new bag. Do not reuse the same vacuum bag.
5. The cardboard face of the new bag should rest securely in the dust bag cover guides.

## Cleaning the HEPA Pre-Motor Filter

**Important, Please Note:** The **HEPA** pre-motor filter will stop most of the microscopic dust particulates and airborne allergens from re-entering the air you breathe. It has been tested and certified up to 99.99% filtration efficiency of all particles as small as 0.3 microns- many times smaller than a human hair! Because of this incredible filtration performance, the **HEPA** pre-motor filter will accumulate many fine dust particles that are difficult to see. Be assured that the **HEPA** pre-motor filter is doing the job. Clean the **HEPA** pre-motor filter after each use as described in this section

1. Remove the shake-out bag from the canister. The **HEPA** pre-motor filter bag is located underneath the shake-out bag. To remove the **HEPA** pre-contents into a motor filter, lift it from the sides of the **HEPA** filter.
2. Vigorously "TapClean" the **HEPA** pre-motor filter on a hard surface to remove any residual dust that might still be on the **HEPA** pre-motor filter.
3. You can wash the **HEPA** pre-motor filter by running it under the tap and allowing the water to run on the dirty side at least once a month or when suction appears to be decreased.

Wash once a year or when suction appears reduced

**WARNING**

Allow 24 hours for drying before replacing in unit.

## HOW TO CHARGE THE BATTERY PACK

When using the charger, basic precautions should always be followed, including the following:

### **Battery and Charging Safety**



To reduce the risk of electric shock, fire, battery explosion, or injury:

Basic information and warning for V-TUF Battery and Charger are contained below. For detailed usage and warning information, read the HOW TO CHARGE THE BATTERY PACK carefully before using this unit.

1. Use only the V-TUF Charger and V-TUF Battery Pack.
2. **DO NOT** expose battery pack to temperatures above 122°F(50°C). Never leave battery packs in automobiles on hot days, where temperatures can be much higher than the outside temperature.
3. **DO NOT** use or store vacuum or batteries in wet or moist conditions, or with flammable or combustible materials.
4. **DO NOT** charge batteries or store battery for extended periods, 1 month or more, in temperatures above 90°F(32°C) or below 40°F(5°C).
5. When charging, make sure that the charger has at least 6 inches of clearance on all sides. Adequate airflow is required to cool the charger when use.
6. Connect charging cord to a properly grounded outlet only. See Grounding Instructions.
7. **DO NOT** use a damaged cord or plug for charging.
8. **DO NOT** pull on charger's cord to unplug. Grasp and pull the plug, not the cord.
9. **DO NOT** handle the charger's cord plug with wet hands when inserting into electrical outlet.
10. Keep sparks and flames away from batteries. Do not smoke near batteries or charger.
11. **DO NOT** charge the unit outdoors.
12. **DO NOT** attempt to repair, service, or modify the battery system or charger. Contact the authorised V-TUF service agent or retailer with any issues.
13. **DO NOT** short-circuit the battery or charger terminals with conductive items such as paper clips. This can deliver high current, resulting in heat and fire.
14. **DO NOT** crush, drop, incinerate or damage the battery pack. **DO NOT** use a battery pack that has been damaged in any way. **DO NOT** incinerate the battery even if it is severely damaged or non working. The battery can explode in a fire.

## CHARGER GROUNDING INSTRUCTION

THE BATTERY CHARGER MUST BE GROUNDED. If the charger should malfunction or stop working, grounding provides a path of least resistance for electrical current, thereby reducing the risk of electrical shock. This unit is equipped with a cord that has an equipment-grounding conductor and grounding plug. The plug must be inserted in an appropriate outlet that is properly installed and grounded in accordance with all local codes and ordinances. Cutting of the ground wire or using a cord that is not equipped with a ground wire will void the warranty on the unit, and V-TUF will accept NO liability associated with the unit.



Improper connection of the equipment-grounding conductor can result in a risk of electrical shock. Check with a Qualified electrician or service person if you are unsure that the outlet is properly Grounded.



# SPECIFICATIONS AND PARTS

## Charger Specification:

Charger input: 100-240V~ 50/60Hz

Charger output: 29.4V 2A

## Battery Specification:

Lithium Polymer chemistry 25.2V

Approximate charge time: 4.0 hours

Approximate run time for new battery: 30 minutes.

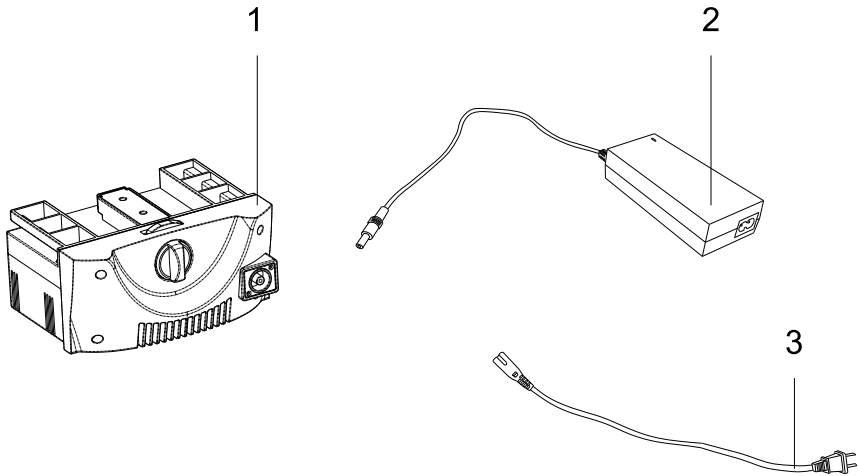

1. Battery pack

2. Charger

3. charger's cord

## OPERATION



Charge in a well ventilated area. DO NOT block charger vents. Keep them clear to allow proper ventilation.

## CHARGING LITHIUM POLYMER BATTERY PACKS

Lithium Polymer batteries deliver fade-free power for their entire run time. The V-TUF vacuum will not gradually lose power due to decreasing battery charge. The vacuum will perform at its normal performance level until the battery has been depleted. Once this

happens, recharging of the battery is required. It is not necessary to drain the battery pack completely before recharging.

If the charger's light is not lit at any point during the charging process, remove the battery pack from the charger to avoid damaging the product. DO NOT insert another battery. Contact the authorised V-TUF service agent with any issues.

## BATTERY PROTECTION FEATURE

The 37-volt Lithium Polymer batteries are designed with features that protect the Lithium Polymer cells and maximize battery life. When the battery has reached its minimum voltage level the electronics will shut off the battery. Once the battery shuts off, it must be recharged.

## PREPARING BATTERY PACK FOR CHARGING

1. Plug the charger's power cord into the charger (Fig 21)
2. Turn off the power switch. Confirm the switch is on the "O" position.
3. Unlock the battery pack by turning knob clockwise and take the battery pack out from the vacuum.(Fig 22)
4. Plug the round connector on the charger's cord into the battery pack. (Fig 23)
5. Plug the charger's power cord into 120V wall outlet (Fig 24)
6. The indicator light will turn red when charging and turn Green when full charged. The Battery pack may require approximately 2.5hours to full charge.

**Note:** Battery pack may get warm while charging.

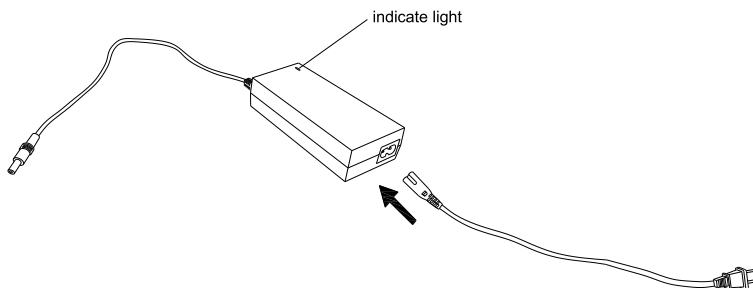

**Fig 21**

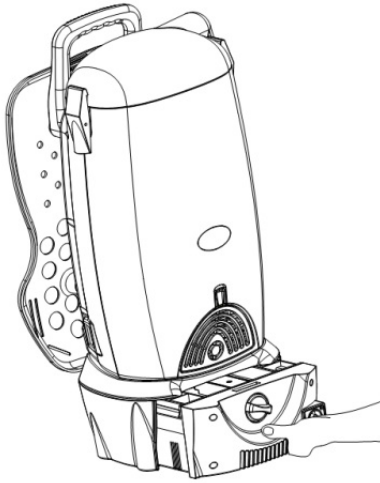

**Fig 24**

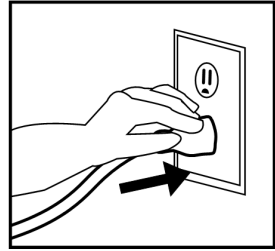

**Fig 22**

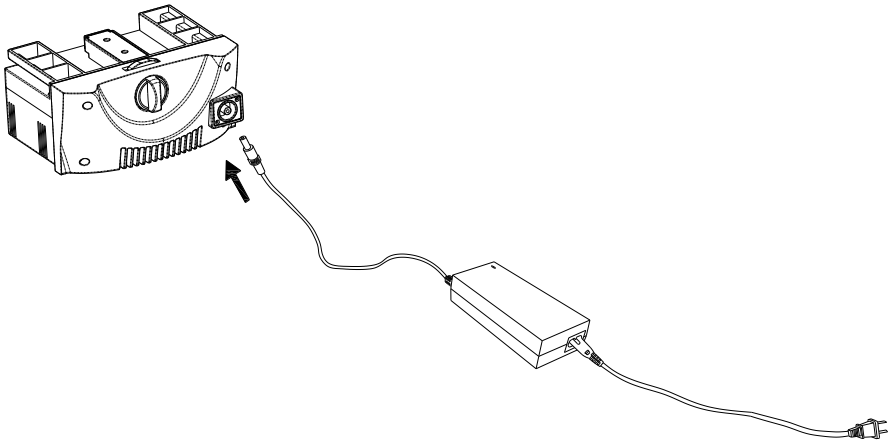

**Fig 23**

**V-TUF.COM**

**V-TUF<sup>®</sup>**